



Saint Michael's *****

MESSENGER

Mission Statement: Saint Michael's Episcopal Church is a
Worshiping body called by Christ to create and sustain a caring
Christian family, addressing the spiritual needs of it's people,
Providing for future growth, and promoting Christ's ministry
And precepts of the Episcopal Church in the community.

NOVEMBER, 2009

ALL SAINTS' DAY PRAYER

Almighty God, you have knit together your elect in
one communion and fellowship in the mystical body of
your Son Christ our Lord: Give us grace so to
follow your blessed saints in all virtuous and godly
living, that we may come to those ineffable joys that you
have prepared for those who truly love you; through
Jesus Christ our Lord, who with you and the Holy Spirit
lives and reigns, one God, in glory
everlasting. Amen.

Vestry Short
October 18, 2009

Finances as of September 30th:

Total Income:	\$12,054
Total Expenses:	\$13,536
Net Income:	\$ (1,327)
Balance in Account:	\$ 1,327

Other Income: Transfer from Savings: \$ 8,000

Other information:

- The insurance company denied our water leak claim in the Priest's office.
- Advent: After the service on the First Sunday of Advent, November 29th, there will be a special teaching and crafts related to Advent. There may also be some devotional materials for people to use during Advent.
- Christmas Eve service will be at 10:00 p.m. There will be Carol Singing followed by a Festival Holy Eucharist.
- Christmas Morning at 10:00 a.m. there will be a drama as part of the Eucharist. This will be immediately followed by the CAYA lunch.
- The St. Michael's Church Welcomes You! folder has been updated and will be part of the Stewardship packet given out on November 1st.
- The theme for this year's Stewardship is: **St. Michael's 2010 by God's Grace...**
 - 1. We are called to be God's people** (Genesis 1:27),
 - 2. We receive God's blessings and spiritual gifts** (Romans 12:6)
 - 3. We share the first fruits of our abundance with others** (Deuteronomy 18:4)

The **Messenger** is published monthly and is published by St. Michael's Episcopal Church at 4070 Jackson St., Riverside, CA 92503

Volume 18-Issue 11– November 1, 2009

- A special statement was formulated and approved by the Vestry as follows:
Believing that all we are and everything we have is a gift, and that we are abundantly blessed, we the Vestry of St. Michael's Episcopal Church affirm the tithe as the biblical standard of giving. We express our own commitment to grow toward this stewardship goal and invite the St. Michael's community to join us in sharing our gifts of time, talent and treasure.
- Our Stewardship Campaign will begin Sunday, November 1st and the ingathering will be on Sunday, November 22nd (the Sunday before Thanksgiving)
- Karen Longman discussed ways to improve our financial reporting.
- The financial reports were discussed, but no action was taken during this meeting.
- Fr. Bill will be out of the office during Thanksgiving Week, from Monday, November 23rd through Friday, November 27th.
- James Guidangen brought up the point that we all need to be united in our goal to solve our problems.

How do I become a member of St. Michael's Episcopal Church?

The short answer is to join us at worship, receive Holy Communion, and work pray and give for the spread of the Kingdom of God (Book of Common Prayer, p. 856)

Generally, any person who has received the Sacrament of Holy Baptism with water in the Name of the Father, Son and Holy Spirit, whether in the Episcopal Church or in another Christian Church, and whose Baptism has been recorded at St. Michael's is considered to be a member here.

It is expected that all adult members (16 years of age and older), after appropriate instruction, will make a mature public affirmation of their faith and commitment to the responsibilities of Baptism and be confirmed or received by the laying on of hands by a Bishop of the Episcopal Church or a Bishop of a Church in communion with the Episcopal Church.

Most people join St. Michael's:

- **By Transfer of Membership:** If you are a member of another Episcopal congregation, simply contact Fr. Bill and let him know of the congregation you wish to transfer from.
- **By Recording Baptism:** If you have been Baptized in another Christian church or denomination, provide Fr. Bill with information about when, where, and by whom the Baptism occurred.
- **By Profession of Faith and Baptism:** If you have accepted the Lord Jesus Christ as your Savior and wish to be baptized, contact Fr. Bill. Once baptized, you will be able to receive Holy Communion.

Information about our corporate and individual duties as Christians and Episcopalians is summarized in our Catechism (BCP, pp. 844-862). Fr. Bill will be reviewing the Catechism in a class called *Discover the Episcopal Church*. Watch your Sunday bulletin, monthly Messenger, and the church website for more information about this class. In the meantime, contact Fr. Bill if you have any questions about life at St. Michael's Church.

Angel Food Ministries

CAYA has now been approved to start the training for the distribution of Angel Food Boxes!!!

What is it?

The Angel Food Program is a wonderful ministry that provides quality food at an affordable price to *all* people, *regardless of income*. Each box is filled with nutritious and restaurant-grade food. There is no purchase limit on the boxes, and anyone can order!

How does it work?

By logging onto the Angel Food Ministries website at

<http://www.angelfoodministries.com/>, you are able to take a look at their monthly menu. Prices range from around \$20-\$30 a box, which can feed a family of four for an entire week or a single person for a whole month! They are also offering boxes for Thanksgiving and Christmas!

How do I order it?

You can place your order directly online! If that does not work for you, feel free to contact Christian Jackson at 831-239-8364, and she will be more than happy to assist you. Angel Food Ministries even accepts food stamps! We are currently partnering with Faith Community Church while we are still in training, but will soon be hosting our own distribution.

Who is this for?

YOU! Everyone is able to order from Angel Food Ministries. There is no application or registration; just log-on and order!

Note: Until CAYA is able to host their own site, please feel free to order from Faith Community Church. Their website is:

<http://www.angelfoodministries.com/host.asp?id=5375>.

Buzzy the Bee heard the animals loved being blessed on October 4th at the Hive. Happy honey gathering to the Daughters of the King Nurturing Hearts chapter which was reinstated on September 27th again at the Hive. The Amazing Women are hovering around the church choir room for their October 30th meeting with Kathleen Phillips as the Queen of the section. All November Birthdays are listed in the church Messenger. The Hive is busy this month with November 1st All Saints Day, the 21st Thanksgiving Pot Luck Feast, November 23rd Fifty-fifth anniversary of the first day at the Hive, November 26th Thanksgiving Day, November 29th United Thank Offering ingathering and Happy New Hive Year.

Joyful Beauty Bee



Grampa Buzzy Bee was reading his granddaughter Buzzy Bees article for the Messenger and wanted to tell the Hive about the activity of the Hive fifty years ago in his youth. Many bees were busy with activities of choirs, acolytes, altar guild, group meetings, youth, plans for the new church on the property at the corner of Jackson and Hawthorne street. Much activity was occurring along with the older members of the Hive in anticipation of the flight to the new Hive. His dance for the future of the Hive included exploration of new flowers to be served for the production of honey in the Lord's work.

Grandpa Bee

The Episcopal Diocese of Los Angeles will elect two Bishops Suffragan as part of our Diocesan Convention, to be held December 4-5 at the Riverside Convention Center. Janet Clark will be St. Michael's lay delegate and Father Bill Dunn will vote as part of the clergy order during the convention.

Bishops Suffragan are elected to act as an assistant to and under the direction of our Diocesan Bishop, The Rt. Rev. J. Jon Bruno. They have historically been elected without right of succession as Diocesan Bishop. The term suffragan is said to come from the Latin *suffragari*, which has been translated "to support with one's vote."

The original group of 51 nominees has been narrowed down to six, from which two will be elected to succeed Bishop Suffragan Chester L. Talton and Bishop Assistant Sergio Carranza, who will retire in 2010 after 19 and seven years, respectively, of service to the Diocese. The final six nominees are:

- The Rev. Canon Diane M. Jardine Bruce, rector, St. Clement's by-the-Sea Church in San Clemente, California;
- The Rev. Canon Mary Douglas Glasspool, canon to the bishops in the Baltimore-based Diocese of Maryland;
- The Rev. Zelda M. Kennedy, senior associate for pastoral care and spiritual growth, All Saints Church in Pasadena, California;
- The Rev. John L. Kirkley, rector, St. John the Evangelist Church in San Francisco (Diocese of California);
- The Rev. Silvestre E. Romero, rector, St. Philip's Church in San Jose California (Diocese of El Camino Real); and
- The Rev. Irineo Martir Vasquez, vicar, St. George's Church in Hawthorne, California.

Please keep the nominees and those participating in the election in your prayers. A suggested prayer from page 818 of the Book of Common Prayer follows:

For the Election of a Bishop or other Minister

Almighty God, giver of every gift: Look graciously on your Church, and so guide the minds of



those who shall choose two bishops suffragan for the Diocese of Los Angeles, that we may receive faithful pastors, who will care for your people and equip us for our ministries; through Jesus Christ our Lord. *Amen.*



The Church Cat:

Even though I am still recuperating from all the excitement around here on St. Francis day I want to take this opportunity to remind you all to count your blessings this Thanksgiving. Here are a couple of General Thanksgiving prayers from the Book of Common Prayer to help you get started:

Accept, O Lord, our thanks and praise for all that you have done for us. We thank you for the splendor of the whole creation, for the beauty of this world, for the wonder of life and for the mystery of love.

We thank you for the blessing of family and friends, and for the loving care which surrounds us on every side.

We thank you for setting us at tasks, which demand our best efforts, and for leading us to accomplishments which satisfy and delight us.

We thank you also for those disappointments and failures that lead us to acknowledge our dependence on you alone.

The Church Cat cont.

Above all, we thank you for your Son Jesus Christ; for the truth of his Word and the example of his life; for his steadfast obedience, by which he overcame temptation; for his dying, through which he overcame death; and for his rising to life again, in which we are raised to the life of your kingdom.

Grant us the gift of your Spirit, that we may know Christ and make him known; and through him, at all times and in all places, may give thanks to you in all things. Amen.



Almighty God, Father of all mercies, we your unworthy servants give you humble thanks for all your goodness and loving kindness to us and to all whom you have made. We bless you for our creation, preservation, and all the blessings of this life; but above all for your immeasurable love in the redemption of the World by our Lord Jesus Christ; for the means of grace, and for the hope of glory. And, we pray, give us such and awareness of your mercies, that with truly thankful hearts we may show forth your praise not only with our lips, but in our lives, by giving up our selves to your service, and by walking before you in holiness and righteousness all our days; through Jesus Christ our Lord, to whom, with you and the Holy Spirit, be honor and glory throughout all ages. Amen.





November 10th	Sarah Reimer	December 2nd	Melissa Ann Schellerup
November ?	Michael Bown	December 12th	John Penland
November 16th	Lillian Gavitt	December 13th	Nicole Reimer
November 21st	Presy Gonzalo	December 15th	Beverly Calamia
November 23rd	Al Mokerski	December 16th	Stewart Bateman
November 29th	Wesley Hughes	December 23rd	David Jones
November 30th	Sally Penland		
November 30th	Sharron Dunn		



November	None
December 24th	Stewart & Monica Bateman

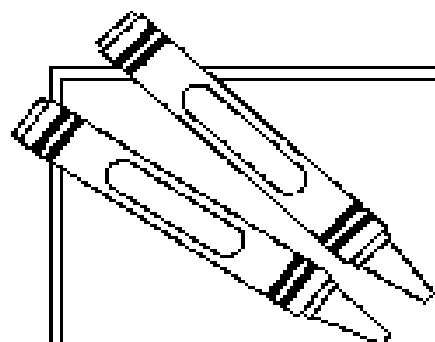









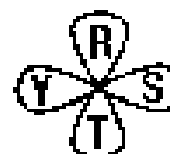
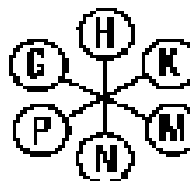
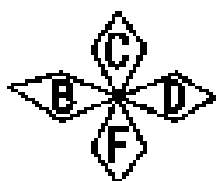

Just for **KIDS**







You Are Special!









Have you heard that no two snowflakes are the same? Each is different – unique – special ... just like each of God's children.

Here are some words from the Bible that talk about this. Use the code to find the missing letters.









" _ e _ e a _ e _ i _ _ e _ e _
         

_ i _ _ _ o _ _ i _ _ , _ u _
          

_ e _ a _ e _ _ i _ i _ .³³ 1 Corinthians 12:4
       

" _ ou a _ e _ _ e _ o _ _ o _
       

_ _ _ i _ _ , a _ _ ea _ _
       

o _ e o _ _ ou i _ a _ a _ _
      

o _ i _ .³³ 1 Corinthians 12:27
 

THE MESSENGER

St. Michael's Episcopal Church
4070 Jackson Street
Riverside, CA 92503
Phone: (951) 689-0642

RETURN SERVICE REQUESTED

TIME DATED MATERIAL

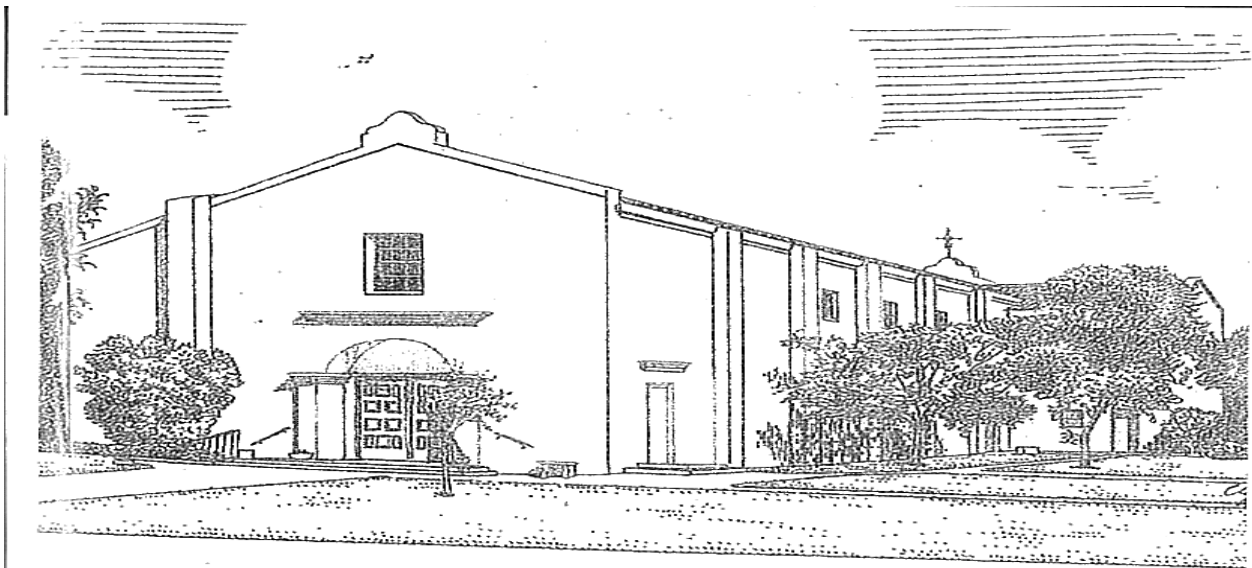

St. Michael's Episcopal Church

Riverside,